

## Data sheet | Item number: 769-231

1-conductor/1-pin carrier terminal block; with shield contact; for DIN-rail 35 x 15 and 35 x 7.5; 4 mm<sup>2</sup>; CAGE CLAMP®

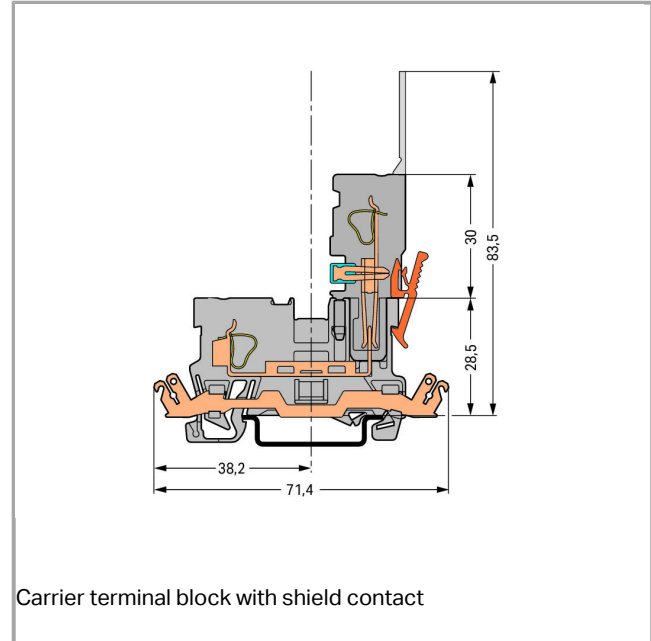

769-231

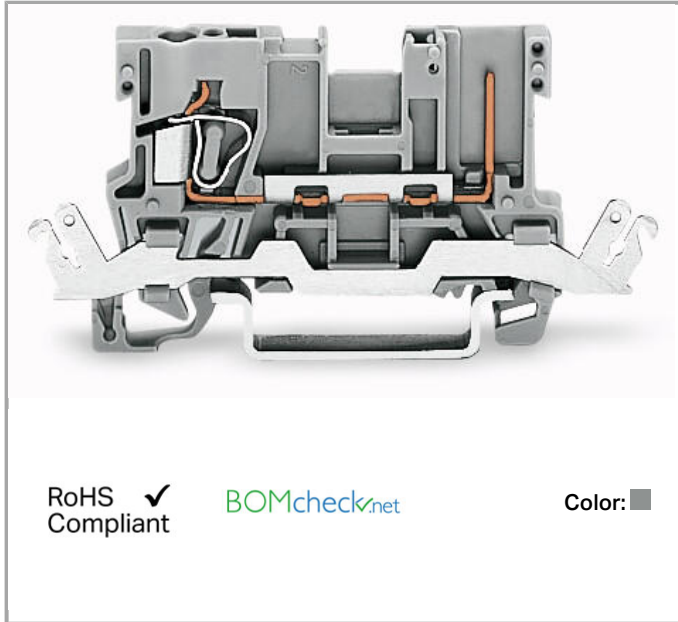

### Data

#### Electrical data

#### Ratings per IEC/EN 60664-1

Rated voltage (III / 3)	250 V
Rated impulse voltage (III / 3)	4 kV
Rated current	32 A

#### Connection data

Connection technology	CAGE CLAMP®
Actuation type	Open Tool Slot
Connectable conductor materials	Copper
Nominal cross section	4 mm <sup>2</sup>
Solid conductor	0.08 ... 4 mm <sup>2</sup> / 28 ... 12 AWG
Fine-stranded conductor	0.08 ... 4 mm <sup>2</sup> / 28 ... 12 AWG
Strip length	8 ... 9 mm / 0.31 ... 0.35 inch
Total number of connection points	1
Total number of potentials	1
Number of levels	1
Type of wiring	Front-entry wiring

## Geometrical Data

Width	5 mm / 0.197 inch
Height from upper-edge of DIN-35 rail	28.5 mm / 1.122 inch
Depth	71.5 mm / 2.815 inch

## Mechanical data

Design	horizontal
Type of mounting	DIN-35 rail
Marking level	Center marking

## Material Data



Color	gray
Insulating material	Polyamide 66 (PA 66)
Fire load	0.104 MJ
Weight	7.516 g

## Commercial data

Product Group	18 (X-COM-System)
Country of origin	DE
GTIN	4050821107415
Customs Tariff No.	85369010000

## Approvals / Certificates

### Country specific Approvals

Logo	Approval	Additional Approval Text	Certificate name
	CCA DEKRA Certification B.V.	EN 60947	NTR NL-7626
	CSA DEKRA Certification B.V.	C22.2 No. 158	1101144
	KEMA/KEUR DEKRA Certification B.V.	EN 60947	2190419.01

### Ship Approvals

Logo	Approval	Additional Approval Text	Certificate name



**ABS**  
American Bureau of Shipping

EN 60947

14-  
HG1293677-  
PDA





**LR**  
Lloyds Register

EN 60947

91/20112  
(E9)

### UL-Approvals

Logo	Approval	Additional Approval Text	Certificate name
	<b>UR</b> Underwriters Laboratories Inc.	UL 1977	E45171
	<b>UR</b> Underwriters Laboratories Inc.	UL 1059	E45172

### Compatible products

#### tools



**Item no.: 210-720**  
Operating tool with partially insulated shaft; Type 2, blade (3.5 x 0.5) mm

210-720

#### End plate



**Item no.: 769-307**  
End and intermediate plate; 1.1 mm thick

769-307



**Item no.: 769-308**  
End and intermediate plate; 1.1 mm thick



















769-308

















#### Carrier rail

































**Item no.: 210-112**  
Steel carrier rail; 35 x 7.5 mm; 1 mm thick; 2 m long; slotted; according to EN 60715; "Hole width 25 mm















210-112















	<b>Item no.: 210-113</b> Steel carrier rail; 35 x 7.5 mm; 1 mm thick; 2 m long; unslotted; according to EN 60715	210-113
	<b>Item no.: 210-114</b> Steel carrier rail; 35 x 15 mm; 1.5 mm thick; 2 m long; unslotted; similar to EN 60715	210-114
	<b>Item no.: 210-115</b> Steel carrier rail; 35 x 7.5 mm; 1 mm thick; 2 m long; slotted; according to EN 60715; "Hole width 18 mm	210-115
	<b>Item no.: 210-118</b> Steel carrier rail; 35 x 15 mm; 2.3 mm thick; 2 m long; unslotted; according to EN 60715	210-118
	<b>Item no.: 210-196</b> Aluminum carrier rail; 35 x 8.2 mm; 1.6 mm thick; 2 m long; unslotted; similar to EN 60715	210-196
	<b>Item no.: 210-197</b> Steel carrier rail; 35 x 15 mm; 1.5 mm thick; 2 m long; slotted; similar to EN 60715	210-197
	<b>Item no.: 210-198</b> Copper carrier rail; 35 x 15 mm; 2.3 mm thick; 2 m long; unslotted; according to EN 60715	210-198
	<b>Item no.: 210-504</b> Steel carrier rail; 35 x 7.5 mm; 1 mm thick; 2 m long; slotted; galvanized; according to EN 60715	210-504
	<b>Item no.: 210-505</b> Steel carrier rail; 35 x 7.5 mm; 1 mm thick; 2 m long; unslotted; galvanized; according to EN 60715	210-505
	<b>Item no.: 210-506</b> Steel carrier rail; 35 x 15 mm; 1.5 mm thick; 2 m long; unslotted; galvanized; similar to EN 60715	210-506
	<b>Item no.: 210-508</b> Steel carrier rail; 35 x 15 mm; 1.5 mm thick; 2 m long; slotted; galvanized; similar to EN 60715	210-508
<b>General accessories</b>		
	<b>Item no.: 280-404</b> Test plug adapter; 5 mm wide; for test plug 210-137 (2.3 mm Ø); suitable for 1.5 mm <sup>2</sup> - 4 mm <sup>2</sup> tbs	280-404
	<b>Item no.: 280-418</b> Test plug module; modular; suitable for all WAGO 280 and 780 Series rail-mounted terminal blocks with jumper slots in the current bar	280-418
	<b>Item no.: 280-419</b> Spacer module; modular; bridging commoned terminal blocks	280-419
	<b>Item no.: 769-438</b> Pin cover; with marker slot for miniature WSB	769-438
	<b>Item no.: 769-439</b> Pin cover; with marker slot for miniature WSB	769-439
	<b>Item no.: 769-501</b> Start module for 1-conductor female connector; with integrated end plate; 4 mm <sup>2</sup> ; 1-pole	769-501
	<b>Item no.: 769-501/000-006</b> Start module for 1-conductor female connector; 4 mm <sup>2</sup> ; 1-pole	769-501 /000-006
	<b>Item no.: 769-501/000-016</b> Start module for 1-conductor female connector; with integrated end plate; 4 mm <sup>2</sup> ; 1-pole	769-501 /000-016















	<b>Item no.: 769-502</b> Center module for 1-conductor female connector; 4 mm <sup>2</sup> ; 1-pole		769-502
	<b>Item no.: 769-502/000-006</b> Center module for 1-conductor female connector; 4 mm <sup>2</sup> ; 1-pole	/000-006	769-502
	<b>Item no.: 769-502/000-016</b> Center module for 1-conductor female connector; 4 mm <sup>2</sup> ; 1-pole	/000-016	769-502
	<b>Item no.: 769-503</b> End module for 1-conductor female connector; 4 mm <sup>2</sup> ; 1-pole		769-503
	<b>Item no.: 769-503/000-006</b> End module for 1-conductor female connector; 4 mm <sup>2</sup> ; 1-pole	/000-006	769-503
	<b>Item no.: 769-503/000-016</b> End module for 1-conductor female connector; 4 mm <sup>2</sup> ; 1-pole	/000-016	769-503
	<b>Item no.: 769-504</b> Start module for 2-conductor female connector; with integrated end plate; 4 mm <sup>2</sup> ; 1-pole		769-504
	<b>Item no.: 769-504/000-006</b> Start module for 2-conductor female connector; with integrated end plate; 4 mm <sup>2</sup> ; 1-pole	/000-006	769-504
	<b>Item no.: 769-504/000-016</b> Start module for 2-conductor female connector; 4 mm <sup>2</sup> ; 1-pole	/000-016	769-504
	<b>Item no.: 769-505</b> Center module for 2-conductor female connector; 4 mm <sup>2</sup> ; 1-pole		769-505
	<b>Item no.: 769-505/000-006</b> Center module for 2-conductor female connector; 4 mm <sup>2</sup> ; 1-pole	/000-006	769-505
	<b>Item no.: 769-505/000-016</b> Center module for 2-conductor female connector; 4 mm <sup>2</sup> ; 1-pole	/000-016	769-505
	<b>Item no.: 769-506</b> End module for 2-conductor female connector; 4 mm <sup>2</sup> ; 1-pole		769-506
	<b>Item no.: 769-506/000-006</b> End module for 2-conductor female connector; 4 mm <sup>2</sup> ; 1-pole	/000-006	769-506
	<b>Item no.: 769-506/000-016</b> End module for 2-conductor female connector; 4 mm <sup>2</sup> ; 1-pole	/000-016	769-506
	<b>Item no.: 769-512</b> Start module for 1-conductor female connector; angled; 4 mm <sup>2</sup> ; 1-pole		769-512















	<b>Item no.: 769-512/000-006</b> Start module for 1-conductor female connector; angled; 4 mm <sup>2</sup> ; 1-pole	769-512 /000-006
	<b>Item no.: 769-512/000-016</b> Start module for 1-conductor female connector; angled; 4 mm <sup>2</sup> ; 1-pole	769-512 /000-016
	<b>Item no.: 769-513</b> Center module for 1-conductor female connector; angled; 4 mm <sup>2</sup> ; 1-pole	769-513
	<b>Item no.: 769-513/000-006</b> 1-conductor center module; angled; codable; 1-pole	769-513 /000-006
	<b>Item no.: 769-513/000-016</b> 1-conductor center module; angled; codable; 1-pole	769-513 /000-016
	<b>Item no.: 769-515</b> 1-conductor end module; angled; codable; 1-pole	769-515
	<b>Item no.: 769-515/000-006</b> 1-conductor end module; angled; codable; 1-pole	769-515 /000-006
	<b>Item no.: 769-515/000-016</b> 1-conductor end module; angled; codable; 1-pole	769-515 /000-016
<b>assembling</b>		
	<b>Item no.: 209-106</b> Mounting carrier; for isolated mounting on DIN 35 rails	209-106
<b>Female plug</b>		
	<b>Item no.: 769-101</b> 1-conductor female plug; 4 mm <sup>2</sup> ; 1-pole	769-101
	<b>Item no.: 769-101/000-006</b> 1-conductor female plug; 4 mm <sup>2</sup> ; 1-pole	769-101 /000-006
	<b>Item no.: 769-101/000-016</b> 1-conductor female plug; 4 mm <sup>2</sup> ; 1-pole	769-101 /000-016
	<b>Item no.: 769-101/022-000</b> 1-conductor female plug; angled; 4 mm <sup>2</sup> ; 1-pole	769-101 /022-000
	<b>Item no.: 769-101/022-016</b> 1-conductor female plug; angled; 4 mm <sup>2</sup> ; 1-pole	769-101 /022-016
	<b>Item no.: 769-102</b> 1-conductor female plug; 4 mm <sup>2</sup> ; 2-pole	769-102















	<b>Item no.: 769-102/000-006</b> 1-conductor female plug; 4 mm²; 2-pole	769-102 /000-006
	<b>Item no.: 769-102/000-036</b> 1-conductor female plug; 4 mm²; 2-pole	769-102 /000-036
	<b>Item no.: 769-102/000-037</b> 1-conductor female plug; 4 mm²; 2-pole	769-102 /000-037
	<b>Item no.: 769-102/022-000</b> 1-conductor female plug; angled; 4 mm²; 2-pole	769-102 /022-000
	<b>Item no.: 769-103</b> 1-conductor female plug; 4 mm²; 3-pole	769-103
	<b>Item no.: 769-103/000-006</b> 1-conductor female plug; 4 mm²; 3-pole	769-103 /000-006
	<b>Item no.: 769-103/000-036</b> 1-conductor female plug; 4 mm²; 3-pole	769-103 /000-036
	<b>Item no.: 769-103/000-037</b> 1-conductor female plug; 4 mm²; 3-pole	769-103 /000-037
	<b>Item no.: 769-103/000-038</b> 1-conductor female plug; 4 mm²; 3-pole	769-103 /000-038
	<b>Item no.: 769-103/000-039</b> 1-conductor female plug; 4 mm²; 3-pole	769-103 /000-039
	<b>Item no.: 769-103/022-000</b> 1-conductor female plug; angled; 4 mm²; 3-pole	769-103 /022-000
	<b>Item no.: 769-104</b> 1-conductor female plug; 4 mm²; 4-pole	769-104
	<b>Item no.: 769-104/000-006</b> 1-conductor female plug; 4 mm²; 4-pole	769-104 /000-006
	<b>Item no.: 769-104/000-036</b> 1-conductor female plug; 4 mm²; 4-pole	769-104 /000-036
	<b>Item no.: 769-104/000-037</b> 1-conductor female plug; 4 mm²; 4-pole	769-104 /000-037



















	<b>Item no.: 769-104/000-038</b> 1-conductor female plug; 4 mm²; 4-pole	769-104 /000-038
	<b>Item no.: 769-104/000-039</b> 1-conductor female plug; 4 mm²; 4-pole	769-104 /000-039
	<b>Item no.: 769-104/022-000</b> 1-conductor female plug; angled; 4 mm²; 4-pole	769-104 /022-000
	<b>Item no.: 769-105</b> 1-conductor female plug; 4 mm²; 5-pole	769-105
	<b>Item no.: 769-105/000-006</b> 1-conductor female plug; 4 mm²; 5-pole	769-105 /000-006
	<b>Item no.: 769-105/000-036</b> 1-conductor female plug; 4 mm²; 5-pole	769-105 /000-036
	<b>Item no.: 769-105/000-037</b> 1-conductor female plug; 4 mm²; 5-pole	769-105 /000-037
	<b>Item no.: 769-105/000-038</b> 1-conductor female plug; 4 mm²; 5-pole	769-105 /000-038
	<b>Item no.: 769-105/000-039</b> 1-conductor female plug; 4 mm²; 5-pole	769-105 /000-039
	<b>Item no.: 769-105/022-000</b> 1-conductor female plug; angled; 4 mm²; 5-pole	769-105 /022-000
	<b>Item no.: 769-106</b> 1-conductor female plug; 4 mm²; 6-pole	769-106
	<b>Item no.: 769-106/000-006</b> 1-conductor female plug; 4 mm²; 6-pole	769-106 /000-006
	<b>Item no.: 769-106/000-036</b> 1-conductor female plug; 4 mm²; 6-pole	769-106 /000-036
	<b>Item no.: 769-106/000-037</b> 1-conductor female plug; 4 mm²; 6-pole	769-106 /000-037
	<b>Item no.: 769-106/000-038</b> 1-conductor female plug; 4 mm²; 6-pole	769-106 /000-038

















	<b>Item no.: 769-106/000-039</b> 1-conductor female plug; 4 mm <sup>2</sup> ; 6-pole		769-106
		/000-039	
	<b>Item no.: 769-106/022-000</b> 1-conductor female plug; angled; 4 mm <sup>2</sup> ; 6-pole		769-106
		/022-000	
	<b>Item no.: 769-107</b> 1-conductor female plug; 4 mm <sup>2</sup> ; 7-pole		769-107
	<b>Item no.: 769-107/000-006</b> 1-conductor female plug; 4 mm <sup>2</sup> ; 7-pole		769-107
		/000-006	
	<b>Item no.: 769-107/000-036</b> 1-conductor female plug; 4 mm <sup>2</sup> ; 7-pole		769-107
		/000-036	
	<b>Item no.: 769-107/000-037</b> 1-conductor female plug; 4 mm <sup>2</sup> ; 7-pole		769-107
		/000-037	
	<b>Item no.: 769-107/000-038</b> 1-conductor female plug; 4 mm <sup>2</sup> ; 7-pole		769-107
		/000-038	
	<b>Item no.: 769-107/000-039</b> 1-conductor female plug; 4 mm <sup>2</sup> ; 7-pole		769-107
		/000-039	
	<b>Item no.: 769-107/022-000</b> 1-conductor female plug; angled; 4 mm <sup>2</sup> ; 7-pole		769-107
		/022-000	
	<b>Item no.: 769-108</b> 1-conductor female plug; 4 mm <sup>2</sup> ; 8-pole		769-108
	<b>Item no.: 769-108/000-006</b> 1-conductor female plug; 4 mm <sup>2</sup> ; 8-pole		769-108
		/000-006	
	<b>Item no.: 769-108/000-036</b> 1-conductor female plug; 4 mm <sup>2</sup> ; 8-pole		769-108
		/000-036	
	<b>Item no.: 769-108/000-037</b> 1-conductor female plug; 4 mm <sup>2</sup> ; 8-pole		769-108
		/000-037	
	<b>Item no.: 769-108/000-038</b> 1-conductor female plug; 4 mm <sup>2</sup> ; 8-pole		769-108
		/000-038	
	<b>Item no.: 769-108/000-039</b> 1-conductor female plug; 4 mm <sup>2</sup> ; 8-pole		769-108
		/000-039	















	<b>Item no.: 769-108/022-000</b> 1-conductor female plug; angled; 4 mm <sup>2</sup> ; 8-pole	769-108 /022-000
	<b>Item no.: 769-109</b> 1-conductor female plug; 4 mm <sup>2</sup> ; 9-pole	769-109
	<b>Item no.: 769-109/000-006</b> 1-conductor female plug; 4 mm <sup>2</sup> ; 9-pole	769-109 /000-006
	<b>Item no.: 769-109/000-036</b> 1-conductor female plug; 4 mm <sup>2</sup> ; 9-pole	769-109 /000-036
	<b>Item no.: 769-109/000-037</b> 1-conductor female plug; 4 mm <sup>2</sup> ; 9-pole	769-109 /000-037
	<b>Item no.: 769-109/000-038</b> 1-conductor female plug; 4 mm <sup>2</sup> ; 9-pole	769-109 /000-038
	<b>Item no.: 769-109/000-039</b> 1-conductor female plug; 4 mm <sup>2</sup> ; 9-pole	769-109 /000-039
	<b>Item no.: 769-109/022-000</b> 1-conductor female plug; angled; 4 mm <sup>2</sup> ; 9-pole	769-109 /022-000
	<b>Item no.: 769-110</b> 1-conductor female plug; 4 mm <sup>2</sup> ; 10-pole	769-110
	<b>Item no.: 769-110/000-006</b> 1-conductor female plug; 4 mm <sup>2</sup> ; 10-pole	769-110 /000-006
	<b>Item no.: 769-110/000-036</b> 1-conductor female plug; 4 mm <sup>2</sup> ; 10-pole	769-110 /000-036
	<b>Item no.: 769-110/000-037</b> 1-conductor female plug; 4 mm <sup>2</sup> ; 10-pole	769-110 /000-037
	<b>Item no.: 769-110/000-038</b> 1-conductor female plug; 4 mm <sup>2</sup> ; 10-pole	769-110 /000-038
	<b>Item no.: 769-110/000-039</b> 1-conductor female plug; 4 mm <sup>2</sup> ; 10-pole	769-110 /000-039
	<b>Item no.: 769-110/022-000</b> 1-conductor female plug; angled; 4 mm <sup>2</sup> ; 10-pole	769-110 /022-000
	<b>Item no.: 769-111</b>	

	1-conductor female plug; 4 mm <sup>2</sup> ; 11-pole		769-111
	<b>Item no.: 769-111/000-006</b> 1-conductor female plug; 4 mm <sup>2</sup> ; 11-pole	/000-006	769-111
	<b>Item no.: 769-111/000-036</b> 1-conductor female plug; 4 mm <sup>2</sup> ; 11-pole	/000-036	769-111
	<b>Item no.: 769-111/000-037</b> 1-conductor female plug; 4 mm <sup>2</sup> ; 11-pole	/000-037	769-111
	<b>Item no.: 769-111/000-038</b> 1-conductor female plug; 4 mm <sup>2</sup> ; 11-pole	/000-038	769-111
	<b>Item no.: 769-111/000-039</b> 1-conductor female plug; 4 mm <sup>2</sup> ; 11-pole	/000-039	769-111
	<b>Item no.: 769-111/022-000</b> 1-conductor female plug; angled; 4 mm <sup>2</sup> ; 11-pole	/022-000	769-111
	<b>Item no.: 769-112</b> 1-conductor female plug; 4 mm <sup>2</sup> ; 12-pole		769-112
	<b>Item no.: 769-112/000-006</b> 1-conductor female plug; 4 mm <sup>2</sup> ; 12-pole	/000-006	769-112
	<b>Item no.: 769-112/000-036</b> 1-conductor female plug; 4 mm <sup>2</sup> ; 12-pole	/000-036	769-112
	<b>Item no.: 769-112/000-037</b> 1-conductor female plug; 4 mm <sup>2</sup> ; 12-pole	/000-037	769-112
	<b>Item no.: 769-112/000-038</b> 1-conductor female plug; 4 mm <sup>2</sup> ; 12-pole	/000-038	769-112
	<b>Item no.: 769-112/000-039</b> 1-conductor female plug; 4 mm <sup>2</sup> ; 12-pole	/000-039	769-112
	<b>Item no.: 769-112/022-000</b> 1-conductor female plug; angled; 4 mm <sup>2</sup> ; 12-pole	/022-000	769-112
	<b>Item no.: 769-113</b> 1-conductor female plug; 4 mm <sup>2</sup> ; 13-pole		769-113

	<b>Item no.: 769-113/000-036</b> 1-conductor female plug; 4 mm²; 13-pole	769-113 /000-036
	<b>Item no.: 769-113/000-037</b> 1-conductor female plug; 4 mm²; 13-pole	769-113 /000-037
	<b>Item no.: 769-113/000-038</b> 1-conductor female plug; 4 mm²; 13-pole	769-113 /000-038
	<b>Item no.: 769-113/000-039</b> 1-conductor female plug; 4 mm²; 13-pole	769-113 /000-039
	<b>Item no.: 769-113/022-000</b> 1-conductor female plug; angled; 4 mm²; 13-pole	769-113 /022-000
	<b>Item no.: 769-114</b> 1-conductor female plug; 4 mm²; 14-pole	769-114
	<b>Item no.: 769-114/000-006</b> 1-conductor female plug; 4 mm²; 14-pole	769-114 /000-006
	<b>Item no.: 769-114/000-036</b> 1-conductor female plug; 4 mm²; 14-pole	769-114 /000-036
	<b>Item no.: 769-114/000-037</b> 1-conductor female plug; 4 mm²; 14-pole	769-114 /000-037
	<b>Item no.: 769-114/000-038</b> 1-conductor female plug; 4 mm²; 14-pole	769-114 /000-038
	<b>Item no.: 769-114/000-039</b> 1-conductor female plug; 4 mm²; 14-pole	769-114 /000-039
	<b>Item no.: 769-114/022-000</b> 1-conductor female plug; angled; 4 mm²; 14-pole	769-114 /022-000
	<b>Item no.: 769-115</b> 1-conductor female plug; 4 mm²; 15-pole	769-115
	<b>Item no.: 769-115/000-036</b> 1-conductor female plug; 4 mm²; 15-pole	769-115 /000-036
	<b>Item no.: 769-115/000-037</b> 1-conductor female plug; 4 mm²; 15-pole	769-115 /000-037

	<b>Item no.: 769-115/000-038</b> 1-conductor female plug; 4 mm <sup>2</sup> ; 15-pole	769-115 /000-038
	<b>Item no.: 769-115/000-039</b> 1-conductor female plug; 4 mm <sup>2</sup> ; 15-pole	769-115 /000-039
	<b>Item no.: 769-115/022-000</b> 1-conductor female plug; angled; 4 mm <sup>2</sup> ; 15-pole	769-115 /022-000
	<b>Item no.: 769-121</b> 2-conductor female connector; 4 mm <sup>2</sup> ; 1-pole	769-121
	<b>Item no.: 769-121/000-016</b> 2-conductor female connector; 4 mm <sup>2</sup> ; 1-pole	769-121 /000-016
	<b>Item no.: 769-122</b> 2-conductor female connector; 4 mm <sup>2</sup> ; 2-pole	769-122
	<b>Item no.: 769-123</b> 2-conductor female connector; 4 mm <sup>2</sup> ; 3-pole	769-123
	<b>Item no.: 769-124</b> 2-conductor female connector; 4 mm <sup>2</sup> ; 4-pole	769-124
	<b>Item no.: 769-125</b> 2-conductor female connector; 4 mm <sup>2</sup> ; 5-pole	769-125
	<b>Item no.: 769-126</b> 2-conductor female connector; 4 mm <sup>2</sup> ; 6-pole	769-126
	<b>Item no.: 769-127</b> 2-conductor female connector; 4 mm <sup>2</sup> ; 7-pole	769-127
	<b>Item no.: 769-128</b> 2-conductor female connector; 4 mm <sup>2</sup> ; 8-pole	769-128
	<b>Item no.: 769-129</b> 2-conductor female connector; 4 mm <sup>2</sup> ; 9-pole	769-129
	<b>Item no.: 769-130</b> 2-conductor female connector; 4 mm <sup>2</sup> ; 10-pole	769-130
	<b>Item no.: 769-131</b> 2-conductor female connector; 4 mm <sup>2</sup> ; 11-pole	769-131
	<b>Item no.: 769-132</b> 2-conductor female connector; 4 mm <sup>2</sup> ; 12-pole	769-132
	<b>Item no.: 769-133</b> 2-conductor female connector; 4 mm <sup>2</sup> ; 13-pole	769-133
	<b>Item no.: 769-134</b> 2-conductor female connector; 4 mm <sup>2</sup> ; 14-pole	769-134
	<b>Item no.: 769-135</b> 2-conductor female connector; 4 mm <sup>2</sup> ; 15-pole	769-135

Coding		
	<b>Item no.: 769-435</b> Coding pin; for coding of female plugs; for carrier terminal blocks / male connectors	769-435
Insulation stop		
	<b>Item no.: 769-470</b> Insulation stop; 0.08 - 0.2 mm <sup>2</sup> "s" (0.14 mm <sup>2</sup> "f-st"); 5 pieces/strip	769-470
	<b>Item no.: 769-471</b> Insulation stop; 0.25 - 0.5 mm <sup>2</sup> ; 5 pieces/strip	769-471
	<b>Item no.: 769-472</b> Insulation stop; 0.75 - 1 mm <sup>2</sup> ; 5 pieces/strip	769-472
Protective Warning Marker		
	<b>Item no.: 280-415</b> Protective warning marker; with high-voltage symbol, black; for 5 terminal blocks	280-415
ferrule		
	<b>Item no.: 216-101</b> Ferrule; Sleeve for 0.5 mm <sup>2</sup> / AWG 22; uninsulated; electro-tin plated	216-101
	<b>Item no.: 216-102</b> Ferrule; Sleeve for 0.75 mm <sup>2</sup> / AWG 20; uninsulated; electro-tin plated	216-102
	<b>Item no.: 216-103</b> Ferrule; Sleeve for 1 mm <sup>2</sup> / AWG 18; uninsulated; electro-tin plated	216-103
	<b>Item no.: 216-104</b> Ferrule; Sleeve for 1.5 mm <sup>2</sup> / AWG 16; uninsulated; electro-tin plated	216-104
	<b>Item no.: 216-201</b> Ferrule; Sleeve for 0.5 mm <sup>2</sup> / 20 AWG; insulated; electro-tin plated	216-201
	<b>Item no.: 216-202</b> Ferrule; Sleeve for 0.75 mm <sup>2</sup> / 18 AWG; insulated; electro-tin plated	216-202
	<b>Item no.: 216-203</b> Ferrule; Sleeve for 1 mm <sup>2</sup> / AWG 18; insulated; electro-tin plated	216-203
	<b>Item no.: 216-204</b> Ferrule; Sleeve for 1.5 mm <sup>2</sup> / AWG 16; insulated; electro-tin plated	216-204
	<b>Item no.: 216-206</b> Ferrule; Sleeve for 2.5 mm <sup>2</sup> / AWG 14; insulated; electro-tin plated	216-206
	<b>Item no.: 216-301</b> Ferrule; Sleeve for 0.25 mm <sup>2</sup> / AWG 24; insulated; electro-tin plated	216-301
	<b>Item no.: 216-302</b> Ferrule; Sleeve for 0.34 mm <sup>2</sup> / 22 AWG; insulated; electro-tin plated	216-302
Marking accessories		
	<b>Item no.: 2009-145</b> Mini-WSB Inline; for Smart Printer; on reel; stretchable 5 - 5.2 mm; plain; snap-on type	2009-145

	<b>Item no.: 2009-145/000-002</b> Mini-WSB Inline; for Smart Printer; on reel; stretchable 5 - 5.2 mm; plain; snap-on type	2009-145 /000-002
	<b>Item no.: 2009-145/000-005</b> Mini-WSB Inline; for Smart Printer; on reel; stretchable 5 - 5.2 mm; plain; snap-on type	2009-145 /000-005
	<b>Item no.: 2009-145/000-006</b> Mini-WSB Inline; for Smart Printer; on reel; stretchable 5 - 5.2 mm; plain; snap-on type	2009-145 /000-006
	<b>Item no.: 2009-145/000-007</b> Mini-WSB Inline; for Smart Printer; on reel; stretchable 5 - 5.2 mm; plain; snap-on type	2009-145 /000-007
	<b>Item no.: 2009-145/000-012</b> Mini-WSB Inline; for Smart Printer; on reel; stretchable 5 - 5.2 mm; plain; snap-on type	2009-145 /000-012
	<b>Item no.: 2009-145/000-023</b> Mini-WSB Inline; for smartPRINTER; on reel; stretchable 5 - 5.2 mm; plain; snap-on type	2009-145 /000-023
	<b>Item no.: 2009-145/000-024</b> Mini-WSB Inline; for Smart Printer; on reel; stretchable 5 - 5.2 mm; plain; snap-on type	2009-145 /000-024
	<b>Item no.: 248-501</b> Miniature WSB Quick marking system; plain; Marker width 5 mm; 10 strips with 10 markers per card	248-501
	<b>Item no.: 248-501/000-002</b> Mini-WSB marking card; as card; not stretchable; plain; snap-on type	248-501 /000-002
	<b>Item no.: 248-501/000-005</b> Mini-WSB marking card; as card; not stretchable; plain; snap-on type	248-501 /000-005
	<b>Item no.: 248-501/000-006</b> Mini-WSB marking card; as card; not stretchable; plain; snap-on type	248-501 /000-006
	<b>Item no.: 248-501/000-007</b> Mini-WSB marking card; as card; not stretchable; plain; snap-on type	248-501 /000-007
	<b>Item no.: 248-501/000-012</b> Mini-WSB marking card; as card; not stretchable; plain; snap-on type	248-501 /000-012
	<b>Item no.: 248-501/000-017</b> Mini-WSB marking card; as card; not stretchable; plain; snap-on type	248-501 /000-017
	<b>Item no.: 248-501/000-023</b> Mini-WSB marking card; as card; not stretchable; plain; snap-on type	248-501 /000-023



**Item no.: 248-501/000-024**  
Mini-WSB marking card; as card; not stretchable; plain; snap-on type

248-501  
/000-024

## check



**Item no.: 210-136**  
Test plug; 2 mm Ø; with 500 mm cable

210-136



**Item no.: 210-137**  
Test plug; 2.3 mm Ø; with 500 mm cable

210-137

## Jumper



**Item no.: 249-123**  
Push-in type wire jumper; insulated; wire length 180 mm; Conductor cross section 0.75 mm<sup>2</sup>

249-123



**Item no.: 249-125**  
Push-in type wire jumper; insulated; wire length 60 mm; Conductor cross section 0.75 mm<sup>2</sup>

249-125



**Item no.: 249-126**  
Push-in type wire jumper; insulated; wire length 110 mm; Conductor cross section 0.75 mm<sup>2</sup>

249-126



**Item no.: 249-127**  
Push-in type wire jumper; insulated; wire length 250 mm; Conductor cross section 0.75 mm<sup>2</sup>

249-127



**Item no.: 280-402**  
Adjacent jumper; insulated; IN = IN terminal block

280-402



**Item no.: 280-409**  
Alternate jumper; insulated; IN = IN terminal block

280-409



**Item no.: 780-452**  
Staggered jumper; insulated; from 1 to 2; Spacing: 5 mm; suitable for 2-conductor female plugs

780-452



**Item no.: 780-453**  
Staggered jumper; insulated; from 1 to 3; Spacing: 5 mm; suitable for 2-conductor female plugs

780-453



**Item no.: 780-454**  
Staggered jumper; insulated; from 1 to 4; Spacing: 5 mm; suitable for 2-conductor female plugs

780-454



**Item no.: 780-455**  
Staggered jumper; insulated; from 1 to 5; Spacing: 5 mm; suitable for 2-conductor female plugs

780-455



**Item no.: 780-456**  
Staggered jumper; insulated; from 1 to 6; Spacing: 5 mm; suitable for 2-conductor female plugs

780-456



**Item no.: 780-457**  
Staggered jumper; insulated; from 1 to 7; Spacing: 5 mm; suitable for 2-conductor female plugs

780-457



**Item no.: 780-458**  
Staggered jumper; insulated; from 1 to 8; Spacing: 5 mm; suitable for 2-conductor female plugs

780-458

## Downloads

## Documentation

## Bid Text

769-231

doc

Download



## CAD/CAE - Smart Data

### CAD data

3D Download 769-231

URL

Download

---

## Product family

### X-COM

[Learn more about the product family.](#)

[Show all products from the family](#)

Subject to changes.

---